

ARF PLUS PRO T33

1/4.5 Scale Almost-Ready-To-Fly RC Jet
Assembly and operations manual



Specifications

Type : T.A.V.S ARF PRO
Scale : 1/4.5th
Length : 94 " (2375mm) Span : 105": (2680mm)
Weight : 34—46 Lbs (15.5—20 Kg)
Engine : 28—34 Lbs (12—16 Kg) trust
Radio : 12 Channel 8—12 servo's)

The T33 Shooting Star by Skymaster

Thank you very much for purchasing our Skymaster ARF PRO T33. Please note that the photos in this instruction manual show certain views from the prototypes. Some modifications and upgrades might have taken place by the release of the model. We have tried to produce a very scale replica of this classic jet. Many scale options are included with your model including very scale speed brakes. This manual describes the assembling of "PRO" model. Sliding canopy, speed brakes, landing gear and doors are factory installed. Before you start building and setting-up your aircraft, please make sure you have read this instruction manual, and understood it. If you have any questions, please don't hesitate to contact us. Below are the contact details:

Office Taiwan:

No.9.39 Lane,Yuag-Chang 2nd Street, Ren-Wu Hsiang, Kaohsiung Hsien, 814, Taiwan, R.O.C.

TEL: +886 9 3299 7923

FAX: + 886 7373 1215

<http://www.skymasterjet.com>

Sales : skymaste@skymasterjet.com

Technical support : morne.m@pixie.co.za

Skymaster
ARF PLUS

T33 arf pro

Assembly & Operation Manual

Index:

INTRODUCTION.....	3
DISCLAIMER.....	3
WARNING.....	3
ARF PAINT.....	4
FINISHING YOUR WHITE VIPER ARF.....	4
HANDLING & TRANSPORTING	5
LIVE HINGE	5
TOOL LIST.....	6
HEALTH.....	7
GENERAL ASSEMBLY TECHNIQUES.....	7
RADIO EQUIPMENT & ACCESSORIES.....	8
KIT CONTENTS.....	9
OPTIONAL PARTS.....	10
CONTROL LINKAGES	12
WINGS.....	12
STABILIZERS.....	15
FIN & RUDDER.....	16
FUSELAGE.....	17
TAILPIPE.....	18
FUEL CELLS.....	18
FUEL DIAGRAM.....	19
AIR SYSTEM	20
AIR DIAGRAM.....	21
TURBINE INSTALLATION.....	22
COCKPIT & CANOPY.....	23
EQUIPMENT INSTALLATION INTO THE F80 ARF.....	24
BEFORE YOU FLY.....	25
OPTIONAL SCALE PARTS.....	26



T33 arf pro

Assembly & Operation Manual

INTRODUCTION

Thank you for purchasing Skymaster arf pro T33! We have put a lot of effort and time into this model. We at Skymaster strive to be a market leader in the ARF—jet market. We were the first company to produce ARF—jets in the world and we would like to continue being amongst the best. Although we have made every effort that this model was fit for shipping, we would like you to inspect the contents and call your nearest dealer immediately if any defects or missing parts are spotted! This manual will allow you to duplicate the factory prototypes.

LIABILITY

You have acquired a kit, which can be assembled into a fully working R/C model when fitted out with suitable accessories, as described in the instruction manual with the kit. However, as manufacturers, we at Skymaster are not in a position to influence the way you build and operate your model, and we have no control over the methods you use to install, operate and maintain the radio control system components. For this reason we are obliged to deny all liability for loss, damage or costs which are incurred due to the incompetent or incorrect application and operation of our products, or which are connected with such operation in any way. Unless otherwise prescribed by binding law, the obligation of the Skymaster company to pay compensation is excluded, regardless of the legal argument employed. This applies to personal injury, death, damage to buildings, loss of turnover and business, interruption of business or other direct and indirect consequent damages. In all circumstances our total liability is limited to the amount which you actually paid for this model.

BY OPERATING THIS MODEL YOU ASSUME FULL RESPONSIBILITY FOR YOUR ACTIONS.

It is important to understand that Skymaster, is unable to monitor whether you follow the instructions contained in this instruction manual regarding the construction, operation and maintenance of the aircraft, nor whether you install and use the radio control system correctly. For this reason we at Skymaster are unable to guarantee, or provide, a contractual agreement with any individual or company that the model you have made will function correctly and safely. You, as operator of the model, must rely upon your own expertise and judgment in acquiring and operating this model.

WARNING

This 'jet' aircraft is a high-end product and can create an enormous risk for both pilot and spectators, if not handled with care, and used according to the instructions. Make sure that you operate your F80 according to the AMA rules, or those laws and regulations governing model flying in the country of use. The engine, landing gear, servos, linkages and control surfaces have to be attached properly. Please use only the recommended servos and accessories. Make sure that the 'Centre of Gravity' is located in the recommended place. Use the nose heavy end of the CG range for your first flights. A tail heavy plane can be an enormous danger for you and all spectators. Fix any weights, and heavy items like batteries, very securely into the plane. Make sure that the plane is secured properly when you start the engine. Have a helper hold your plane from the nose before you start the engine. Make sure that all spectators are far behind, or far in front, of the aircraft when running up the engine. Make sure that you range check your R/C system thoroughly before the 1st flight. It is absolutely necessary to range check your complete R/C installation first WITHOUT the engine running. Leave the transmitter antenna retracted, and check the distance you can walk before 'fail-safe' occurs. Then start the engine, run at about half throttle and repeat this range check. Make sure that there is no range reduction before 'fail-safe' occurs. If the range with engine running is less than with the engine off, please DON'T FLY at that time. Make sure that your wing spar tube is not damaged. Check that the anti-rotation dowels for the wings are not loose. Check that the wing, stab, fin and nose retaining bolts are tight. Please don't ignore our warnings, or those provided by other manufacturers. They refer to things and processes which, if ignored, could result in permanent damage or fatal injury. Secure the plane before starting engine.



T33 arf pro

Assembly & Operation Manual

ARF Paint

The color finish on your Skymaster T33 arf pro model was applied out of the mould. We have used only the highest standard automotive paints to finish your model.

Should you damage the finish, Skymaster stock the color paint and hardener required for the repair. A good automotive spray painter should also be able to mix and supply the correct samples for repair.

If you have no experience in the use of these paints, it will be best to seek assistance.

Do not leave your model unprotected in the sun! always cover your model or park it in the shade. Extreme temperatures will damage the paint!

Finishing Your All White T33 ARF PRO

It is always best to fully assemble the model before painting. By doing so no damage or glue prints will ruin the paint.

The all white model will have some release agent on the surfaces.

Use #1000 wet and dry paper to sand the entire model. Mould lines can be sanded and filled using normal automotive fillers.

Please be extra careful when sanding near the hinge line! The hinges can easily be damaged. When masking and painting please make sure the control surfaces are not bend past 90—180 degrees extensively. This will cause the hinges to crack and may cause flutter.

The rudder and clear canopy are not installed. It is best to install these components after painting was done.



T33 arf pro

Assembly & Operation Manual

HANDLING & TRANSPORTING

Composite models are very light but strong. These characteristics do have a down side! It is brittle.

Take care when handling your model. DO NOT ATTEMPT TO PICK UP AN FULLY FUELED MODEL BY THE LEADING EDGE BY YOURSELF! The leading edges will crack and delaminate. Full size jets have specially marked access points for the hooks of cranes!

Inspect your model before and after a rough landing. Make sure all parts are safe and sound.

Inspect model before and after transport. A sudden stop can easily cause an unnoticed dent!

The wings and tails are very flight worthy structures. They are light and extremely strong , however, they will dent if mishandled. Always support these structures on clean soft foam rubber.

LIVE HINGE

Skymaster utilize this system of hinging control surfaces because it is a very strong hinge system and is accomplished at the factory.

Occasionally, because of climatic changes, the bottom surfaces may “catch” or interfere with control travel surface actuation. Should this happen, use a fine abrasive strip to further bevel the L.E. of the control surface.

CAUTIONS: Do not apply any primer or paint to the underside of the main surface trailing edge.

Prior to each flight, check that the ailerons and elevators actuate properly, up and down.

Inspect the live hinges on a regular basis. If some cracks occur please repair asap with special hinge tape available from Skymaster or its dealers.



T33 arf pro

Assembly & Operation Manual

Tools and Adhesives

Tools etc:

This is a fairly quick and easy plane to build, for a jet model, not requiring difficult techniques or special equipment, but even the building of Skymaster aircraft requires some suitable tools! You will probably have all these tools in your workshop anyway, but if not, they are available in all good hobby shops, or hardware stores like "Home Depot" or similar.

1. Sharp knife (X-Acto or similar)
2. Allen key set (**metric**) 2.5mm, 3mm & 5mm
3. Sharp scissors, curved type for canopy
4. Pliers (various types)
5. Wrenches (**metric**)
6. Slotted and Phillips screwdrivers (various sizes)
7. Drills of various sizes
8. Battery drill and Dremel tool (or similar) with cutting discs, sanding tools and mills
9. Sandpaper (various grits), and/or Permagrafit sanding tools.
10. Carpet, bubble wrap or soft cloth to cover your work bench (most important !)
11. Car wax polish (clear)
12. Paper masking tape
13. Denaturized alcohol, Acetone, or similar (for cleaning)



Adhesives:

Not all types of glues are suited to working with composite parts. Here is a selection of what we normally use, and what we can truly recommend. Please don't use inferior quality glues - you will end up with an inferior quality plane, that is not so strong or safe. Jet models require good gluing techniques, due to the higher flying speeds, and hence higher loads on many of the joints. We highly recommend that you use a slow cured epoxy for gluing highly stressed joints, like the hinges and control horns, into position and the most commonly used is 'Aeropoxy' (Bob Violett Models, USA). The self-mixing nozzles make it easy to apply. It takes about 1 - 2 hours to start to harden so it also gives plenty of time for accurate assembly. Finally it gives a superb bond on all fibreglass and wood surfaces.

1. CA glue 'Thin' and 'Thick' types. We recommend ZAP, as this is a very high quality.
2. ZAP-O or Plasti-ZAP, odourless (for gluing the clear canopy)
3. 30 minute epoxy (stressed joints must be glued with 30 min and NOT 5 min epoxy).
4. Aeropoxy/Loctite Hysol 3462 or equivalent (optional, but highly recommended)
5. Epoxy laminating resin (12 - 24 hr cure) with hardener.
6. Milled glass fibre, for adding to slow epoxy for stronger joints.
7. Micro-balloons, for adding to epoxy for lightweight filling.
8. Thread-locking compound (Loctite, or equivalent)

At Skymaster we try our best to offer you a high quality kit, with outstanding value-for money, and as complete as possible. However, if you feel that some additional or different hardware should be included, please feel free to let us know.



T33 arf pro

Assembly & Operation Manual

HEALTH

Use a mask (available at auto paint stores) to protect from inhaling the glass or carbon fiber dust. Use this mask whenever you are sanding or cutting fiberglass or carbon fiber materials. Use a charcoal filter paint mask (available at auto paint supply stores) when spraying any primer or paint. Spray out of doors or in a properly vented spray booth. Use safety glasses any time rotary tools, such as Dremel cut-off disc or Perma-Grit cutters, are being used.

GENERAL ASSEMBLY TECHNIQUES

We recommend to wax the model before assembling. This will help protect the finish from an epoxy finger print. Wax will not help for CA glues!

Extra glue, extra paint, extra resin will add up to a heavy model. Plan before you glue! The glass cloth side of parts to glue, should be sanded with #80 grit paper for best glue adhesion.

Support the fuselage on foam pads.

Skymaster makes every attempt to insure that the parts fit. However, due to manufacturing tolerances, some parts may fit a little tight. Always trial fit parts and adjust if needed.

Only use high quality adhesives such as the ZAP products from Pacer Technology.

For extremely high stress areas we recommend "Aeropoxy." It is the strongest and best gripping adhesive we have found.

If fuel or grease are on the surface, first clean with acetone or thinners.

Clean off all excess glue—excess glue is excess weight.

Always check the outside skin of the model to look for any glue residue and remove it with Acetone before it cures. "Aeropoxy" is tough to remove once it has thoroughly cured.



T33 arf pro

Assembly & Operation Manual

Radio equipment

Failure to use the recommended servos, output arms, extensions, and hardware may result in a loss of control!

Throughout this manual we make use of various types of servos and radio equipment! We have used JR equipment during the installation process. If you make use of another manufacturer, please use equipment with similar specifications!

The T33 will require extension leads! Please use high quality extension leads. Make use of ceramic non ferrite cores if leads exceeds 1 meter.

The trend nowadays is to use dual battery management systems and dual RX equipment. With the introduction of 2.4 Ghz even quad RX systems are considered as normal for a jet model.

Always center and install the correct output arms while on the bench, once the servo is in the aircraft access to the servo arm screw is sometimes limited.

Do not save any money when buying radio equipment. The price of servo's are far from the price of replacing the entire model.

REMEMBER: The best equipment is only as good as the weakest link. Ask yourself if this servo or link or lead etc is worthy of my trust to protect my very large investment...

Accessories

1. 2 DS8411 servo's for the elevator.
2. 1 DS8411 for rudder.
3. 2 DS8411 servo's for ailerons
4. 2 DS8511 servo's for flaps
5. 1 JR8511 steering servo.
6. 3 JR577servos for Landing Gear, Door and Brake valves or check next line.
7. 1 Airpower EV5U valve + 1 x EV2U valve for landing gear + doors + brakes
8. 1 EV2U valve for speed brake
9. 1 EV2U valve for sliding canopy
10. Powerbox Royal with build in matchbox function.
11. Pneumatic support set for landing gear
12. Turbine motor, with thrust range between 12kg and 16kg, with accessories.
13. Fuel tubing, Hopper tank (or BVM UAT), festo fittings, fuel filters, fuel tube etc.
14. Cable ties in various lengths.

***Did you understand everything in this manual completely?
Then, and only then, let's start assembling your F-80.
If not, please read it again before you start the assembly.***

T33 arf pro

Kit Contents

Assembly & Operation Manual

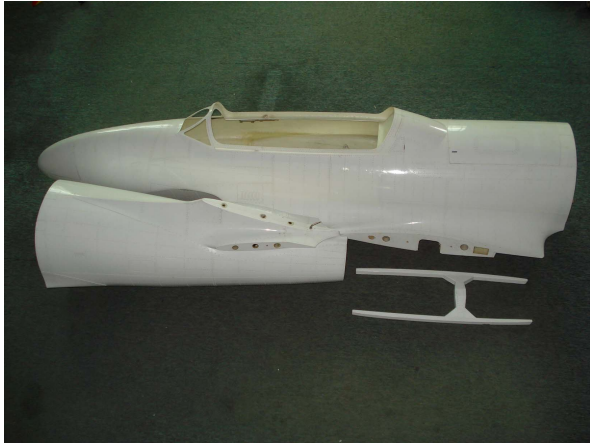

Photo A

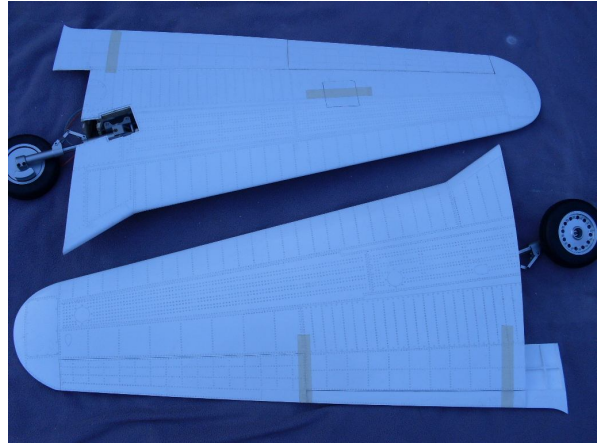

Photo B

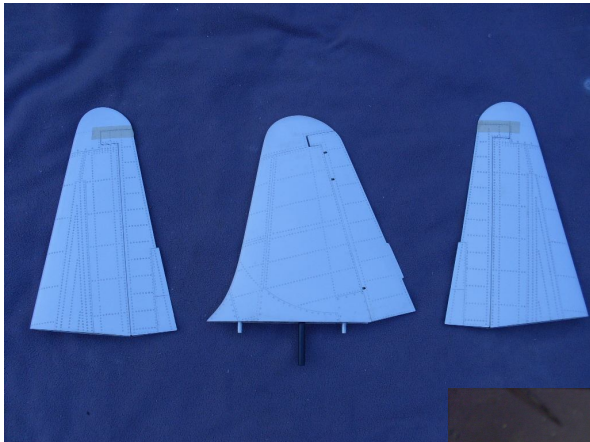

Photo C



Photo D



Photo E

F80 ARF PRO Contents:

- Picture A Fuselage front and rear including nose gear + door installed + speed brake installed
- Picture B Wings including L/G + Doors installed. Include flap + Aileron
- Picture C Fin & Rudder & Stabs & Elevators
- Picture D Optional tip tank
- Picture E Nose cone and Engine Hatch



T33 arf pro

Assembly & Operation Manual

OPTIONAL PARTS



Photo 1

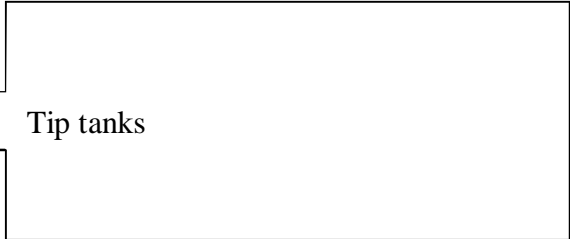

- 3 x Air Tanks
- 1 x Retract Valve
- 2 x Filler & 2 x Pressure Gauges
- 1 x Electronic Brake Valve
- 5 x Air Tubing, 10 x Quick Disconnect
- 8 x T-pieces, 2 x 4 way



Photo 2



Photo 3

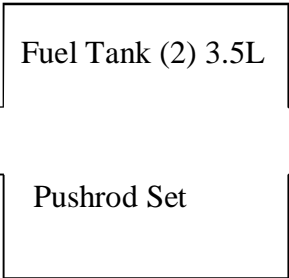

Photo 4



Photo 5

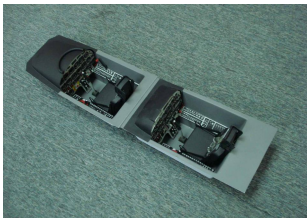
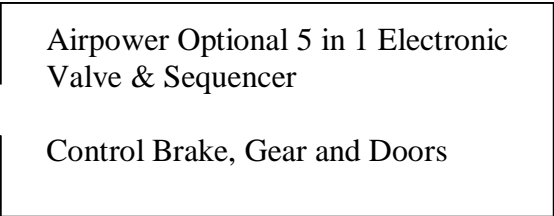

Photo 6

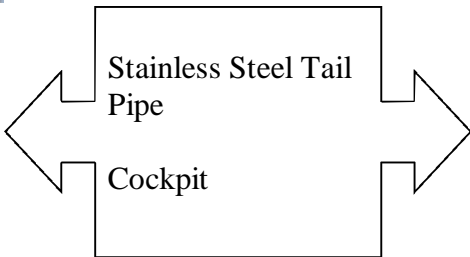

Photo 7



T33 arf pro

Assembly & Operation Manual



Photo 8

Servo mounting hardware

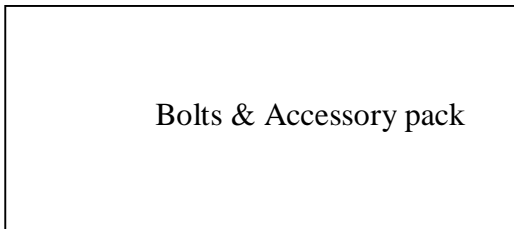

Bolts & Accessory pack



Photo 9



Photo 10

Belcrank wire

Carbon Bypass



Photo 11



Photo 12

L/G hydrolic set



Photo 13

Tygon Tubing

Tank Hardware



Photo 14

Skymaster
ARF PLUS

T33 arf pro

Assembly & Operation Manual

CONTROL LINKAGES



Photo 15

Flaps : 63mm (2)

Aileron : 62mm (2)

Elevator : 80mm (2)

Rudder : 130mm (2)

Steering: 50mm

WINGS

NOTE: Make sure to have some sort of protective foam on the work bench. This will protect the paint surface from unwanted dents. Assemble both wings simultaneously. Mark ✓ each step.

- Check operation of Landing gear and doors.
- Remove factory self tapping L/G screws and replace with high quality screws.
- Inspect landing gear blocks. Make sure all parts are glued.



Photo 16

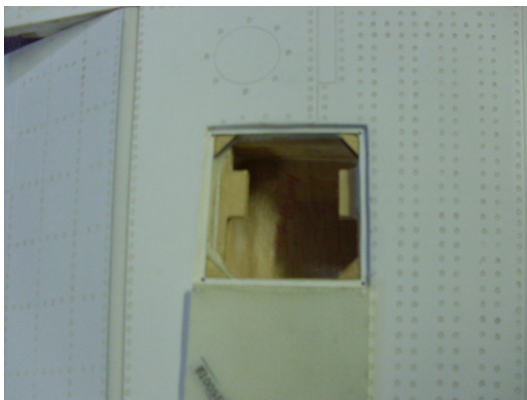

Photo 17

- Fit quick disconnects to air line.
- Tighten brake drum.
- Check the operation of brake
- Remove and mark servo covers and inspect plywood. Use dremel to clean out some glue and ply to make sure servos will fit well.



T33 arf pro

Assembly & Operation Manual

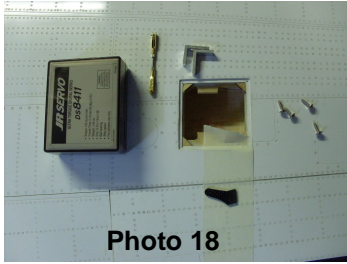

Photo 18

- Locate all items needed to complete wings. Fit 2 L-shape servo brackets to 1 x JR DS8411 servos.
- Aileron servo must be mounted with horns facing up. The horn must be closest to control surface and furthest away for root.

- Secure servo horns and centre servo's with TX.
- Secure extension wire. Use safety clips on joint.
- Secure servo's to wing. Use 4 servo screws.
- Draw a line perpendicular to hinge line.

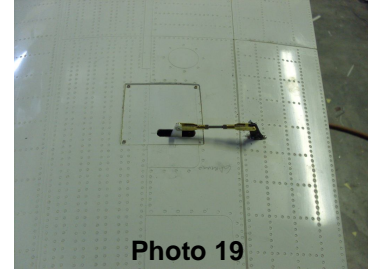

Photo 19



Photo 20

- Mark location of horn on aileron. Drill horn 1.5mm for link
- Use Dremel to mill slot for control horns.
- Use 30 minute epoxy to glue control horns
- After epoxy cured, insert pushrods and secure safety clips.
- Check operation of aileron.
- Mill slot in servo cover and secure with 4 x 1mm set screws.

- File the hole for flap servo in wing. Make sure of good fit.
- Setup servo for flap function on radio and fasten servo horn. The horn must face the top surface of wing and leading edge.

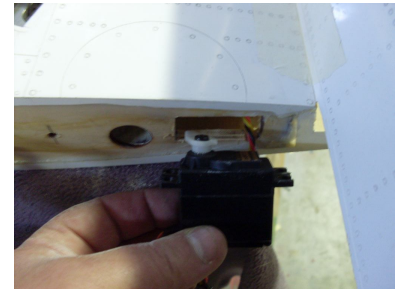

Photo 21



Photo 22

- Fasten flap in 45 degree position and cut slot in trailing edge for pushrod.



Photo 23

Skymaster
ARF PLUS

T33 arf pro

Assembly & Operation Manual

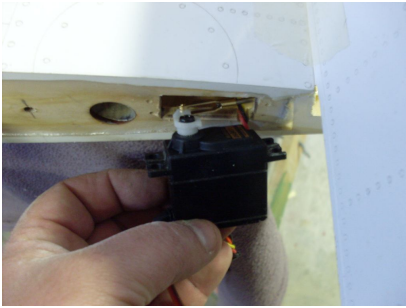

Photo 24

- Make up flap pushrod. Make up 2.
- Fit pushrod to servo horn and secure safety clip.
- Slide pushrod through hole in trailing edge and fasten servo with 4 screws.

- Locate flap horn and sand bottom. Rough carbon to make sure good contact with glue. Drill 1.5mm hole for link.

- Draw line on flap in line with flap pushrod
- Mark location of flap horn 6mm above flap webbing.
- Glue piece of 6mm balsa in horn position. Mill slot in balsa and flap. Take care not to mill right through flap.
- Use good quality CA glue and accelerator to glue horn flap inner surface and balsa block.
- Insert pushrod and insert safety clips.
- Check that flap operate correctly and freely.
- Repeat for other wing.

- Trial fit wings to fuselage and mark location of hole for servo. Mill if needed.
- Secure wing with 2 bolts on each side.

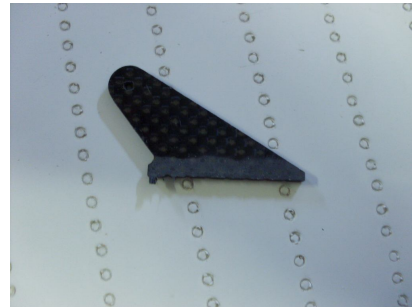

Photo 25

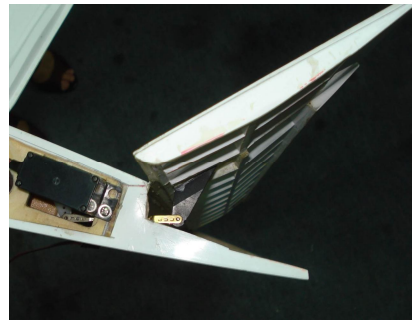

Photo 27

to



Photo 28



T33 arf pro

Assembly & Operation Manual

STABILIZERS

NOTE: Make sure to have some sort of protective foam on the work bench. This will protect the paint surface from unwanted dents. All linkages on out side. If you require the linkage to be inside, please modify by yourself. To remove stabilizers for repair to elevator servo will require removing tailpipe. Mark ✓ each step.

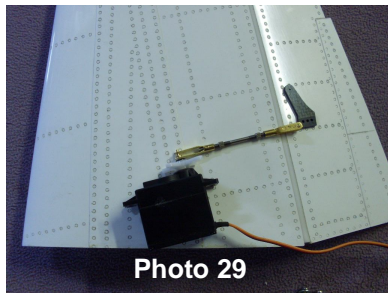

Photo 29

- Locate all parts for this section
- Mark hole 62x22 on root of stab and cut with dremel.
- Fit 2 x L-brackets to servo. NOTE : L-bracket on outside of servo mount. Cut plastic support to make sure L-bracket fit tight. Fit horn and centre servo.
- Cut piece of 1/16" ply and fasten servo to ply. Sand bottom flat to remove some of screw. This flat bottom will be glued to stab.



Photo 30

- Mark location of servo horn and mill slot in bottom skin of stab.
- Mix 5 minute epoxy and glue servo plate to top skin of stab. Make sure servo horn is centre through bottom skin.

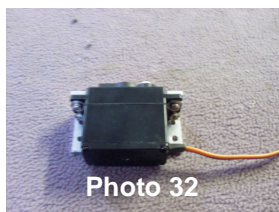

Photo 32

- Mark location of elevator horn and mill slot.
- Drill 1.5mm hole in horn and glue to elevator with 5 minute epoxy
- Make up pushrod and secure with safety clips.



Photo 34

- Repeat for other stab.
- Secure to fuselage with bolt.

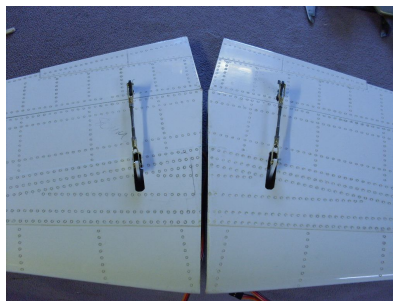

Photo 36



Photo 31

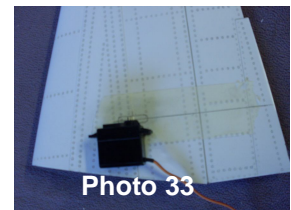

Photo 33

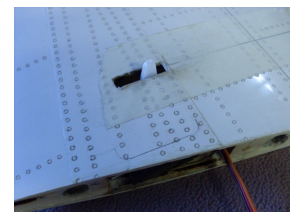

Photo 35



T33 arf pro

Assembly & Operation Manual

FIN & RUDDER

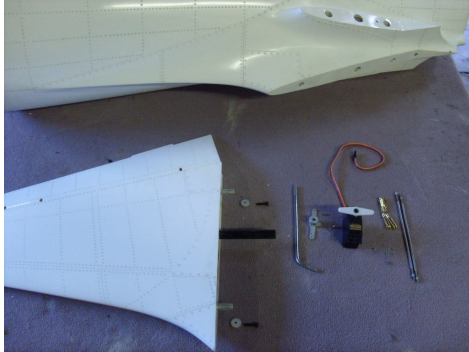

Photo 36

NOTE: Make sure to have some sort of protective foam on the work bench. This will protect the paint surface from unwanted dents. Note that later models may have different rudder belcrank. Mark ✓ each step.

- ☐ Locate all parts needed for this section.



Photo 37

- ☐ Make up rudder push rods (2).
- ☐ Fit wire belcrank in position. Fit belcrank over wire and mark location of set screws. NB. Note the position of belcrank on wire.
- ☐ Cut flat sections into wire and secure belcrank to wire with loctide.
- ☐ Fit servo to servo plate with 4 set screws.
- ☐ Fit pushrods to servo horn and belcrank. Use safety clips.
- ☐ Make sure servo horn and belcrank form 90 degree angle.
- ☐ Fit fin to fuselage and secure with 2 bolts. Clamp carbon fin spar.
- ☐ Operate rudder to check correct operation.

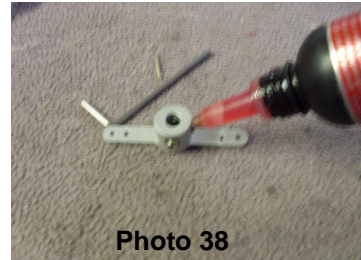

Photo 38

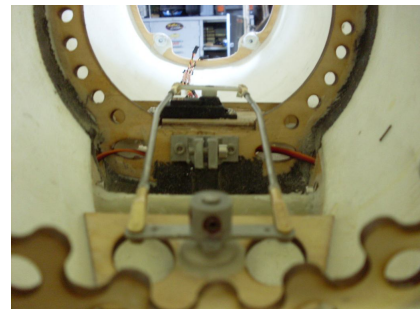

Photo 39



Photo 40

NOTE: To service rudder servo it will be necessary to remove tail pipe and split fuselage. Make sure all work fine before proceeding.



T33 arf pro

Assembly & Operation Manual

FUSELAGE

Make sure you have a good stand for fuselage. You will need to assemble the rest of the F80 on this stand.



Photo 41

- Before joining the fuselage it is necessary to tidy up the servo wires. Make sure wires are secure and will not touch the tailpipe.
- Slide tailpipe into rear section. Make sure you have drilled the holes in the mounting tabs of the tailpipe. It is impossible to remove tailpipe once the fuselage is joined. Also twist tabs 90 degrees.

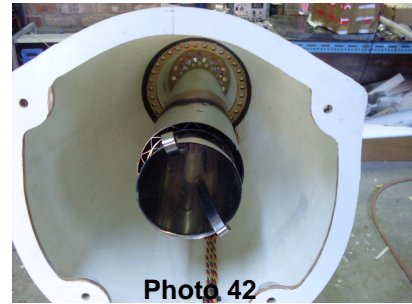

Photo 42

- Align fuselage and secure with 4 x M5 bolts and washers. Check fit all around seem for sound joined.
- Route 3 servo wires along inner skin of rear fuselage.
- Install servo male and female plugs for 3 servo wires.
- For future service I recommend that the 3 wires are joint via a male female plug at fuselage joint.



Photo 43

- Turn fuselage upside down
- Remove nose oleo unit.
- Install JR DS8511 steering servo. Bolt with 4 x M3 bolts and lock nuts.
- Centre servo and install pushrod.
- Refit nose oleo and check operation of gear doors.

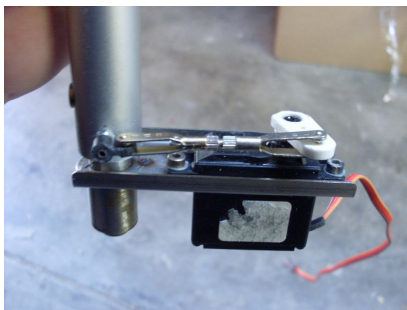

Photo 44

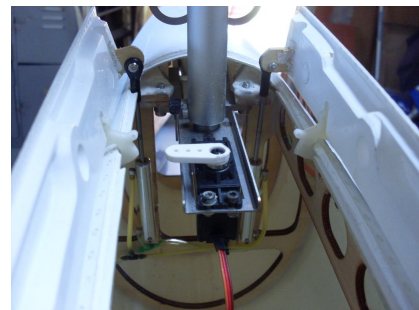

Photo 45

Skymaster
ARF PLUS

T33 arf pro

Assembly & Operation Manual

TAIL PIPE (before inserting tail pipe and bypass see section about air cylinder installation. All 4 air cylinders are mounted beneath bypass)

- ☐ Slide carbon bypass duct into tailpipe. P46
- ☐ Mark location of screws and secure tailpipe to engine rail.
- ☐ Use some silicon between tailpipe and bypass.
- ☐ Secure bypass to turbine rail.
- ☐ Secure pipe in position and glue end of pipe with silicon glue to former.

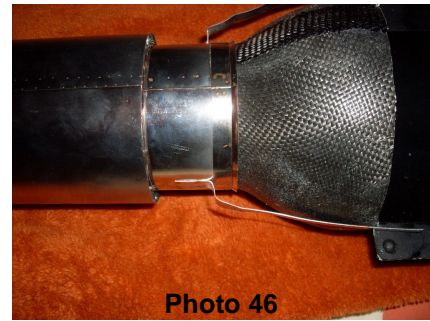

Photo 46

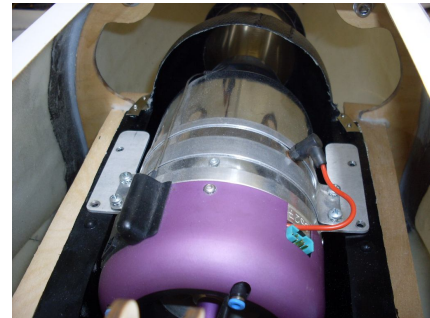

Photo 47

FUEL CELLS

NOTE: Bad plumbing lead to flame outs. This will destroy your model. Please take your time and do a good job.

- ☐ Rinse fuel tanks and check for leaks.
- ☐ Make up fuel line fittings. Make sure clunk moves freely and reaches all corners of inside of tanks.
- ☐ Fit to tank. Mark pipes for "inlet" and "outlet".
- ☐ Secure tanks in position.



Photo 48



Photo 49

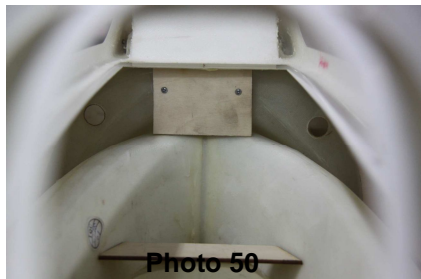

Photo 50

- ☐ Plumb tank using diagram on next page.
- ☐ Fill tank and check for leaks.
- ☐ Drain tank with turbine fuel pump and check no air Bubbles in system until last drop is drained. A good plumbing will secure good turbine operation.



T33 arf pro

Assembly & Operation Manual

FUEL CELL DIAGRAM

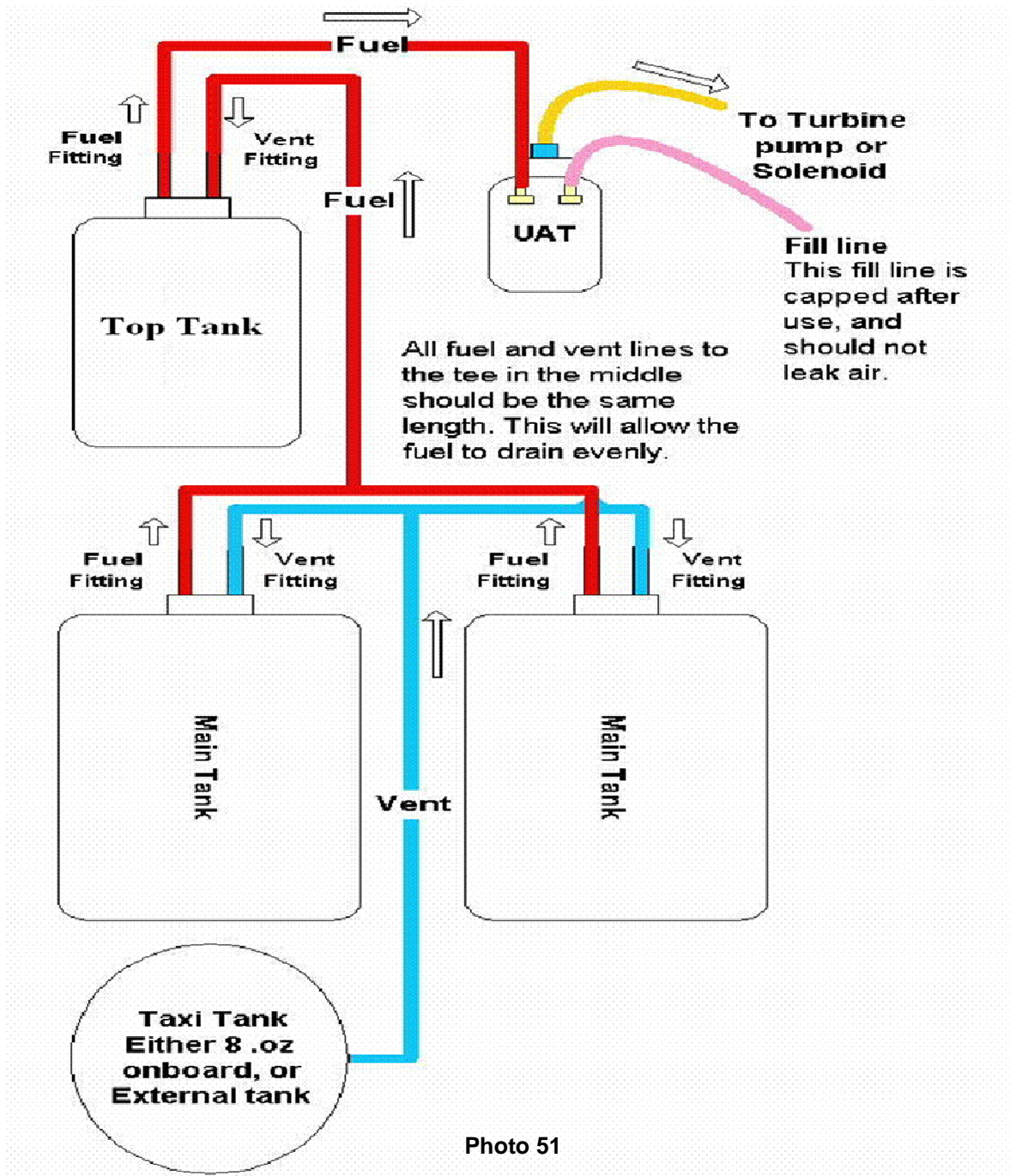

Skymaster
ARF PLUS

T33 arf pro

Assembly & Operation Manual

AIR SYSTEM There are 2 options available for the air system: **Mechanical** or **Electronic**. For mechanical you will need 4 x 2 way and 1 x 1way valve with 5 servos and sequencer. For electronic you will need 1 x EV5U and 2 x EV2U.

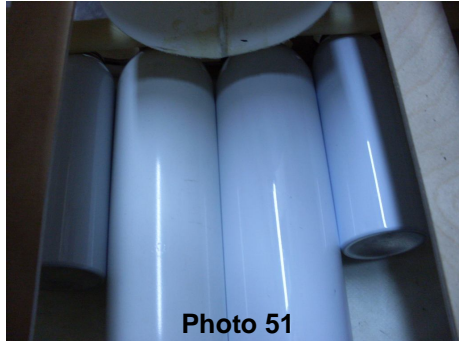

Photo 51

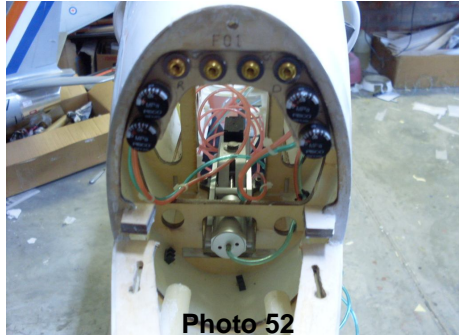

Photo 52

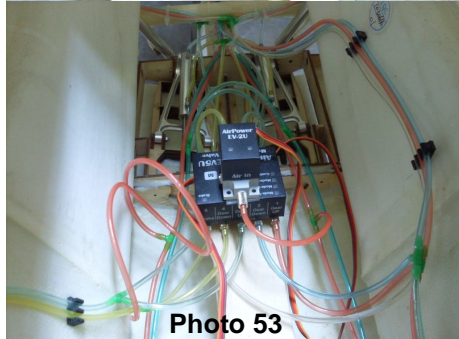

Photo 53

- Glue the air tanks with silicon glue underneath the turbine (bypass). 2 large tanks for doors and retracts and smaller tanks for speed brake and opening canopy mechanism.
- Fit the 4 filler valves and 4 pressure gauges onto horse shoe plywood cut from scratch. Glue in nose section (P52)
- Plumb the landing gear, door and brake system by using color air tubing. T all same color tubing together until a single pipe emerge. Fit electronic EV5U valve underneath cockpit
- Route all 5 pipes to EV5U.
- Plumb speed brake and canopy.
- Secure 2 x 2way electronic valves adjacent to EV5U. This will be for speed brake and canopy.
- The air system will consist of :

Air up, Air down retracts (2)
Air up, Air down doors (2)
Air out brakes (1)
Air up, Air down speed brake (2)
Air up, Air down canopy (2)
Air in (2)

Total of 11 pipes

- Air leaks can damage your model! Please do a thorough check for air leaks. Make sure the system can hold pressure for at least an hour in the up and down position.
- Do not rush this installation.



T33 arf pro

Assembly & Operation Manual

- For scale functions such as speed brake and sliding canopy you will require additional 2 way electronic valves.



Photo 54 2 way

AIR DIAGRAM

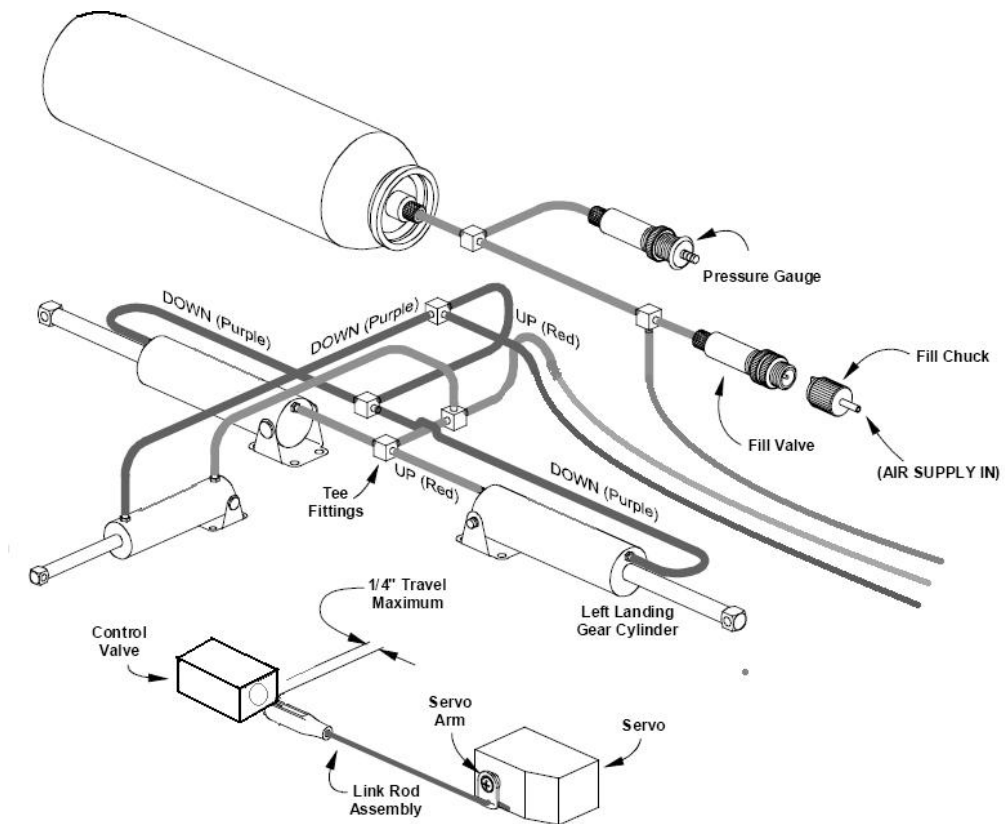

Photo 55 Diagram for retracts



T33 arf pro

Assembly & Operation Manual

TURBINE INSTALLATION

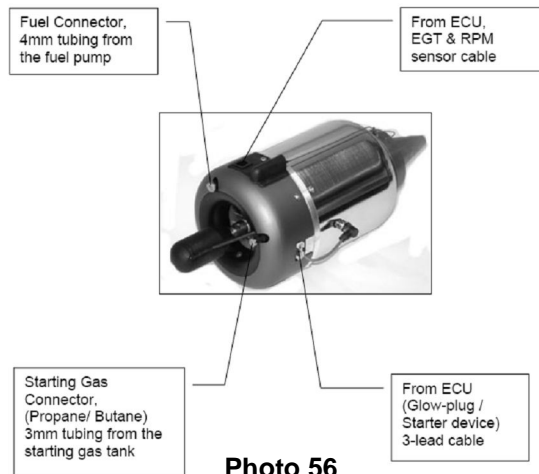

- Please follow the instructions supplied with your turbine.
- Secure turbine to turbine rail via hatch at bottom of fuselage. Leave gap of 25mm between NGV and tailpipe.
- Run all turbine wires and power cables on opposite side of servo wires.
- Always secure all wires in harness. I would suggest you install a FOD. This will save you money in the long run.

Electrical connection pictures

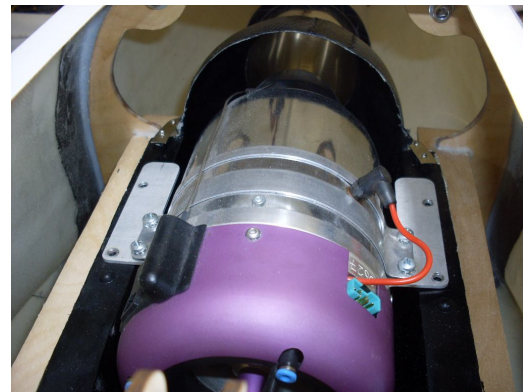
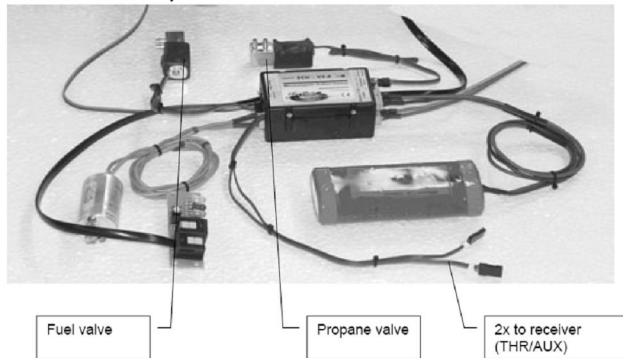

- Install fuel pump close to UAT. We recommend to make use of a mechanical shut off valve as well.
- Secure all Festo pipes with cable ties. Make sure fuel filter and gas canister are mounted vertical.
- Install NiCad or Li Po battery in nose. I always put a fuse holder inline with power cable.
- Trial fit bypass top cover. Cut slots and secure with hook & loop tape.



T33 arf pro

Assembly & Operation Manual

COCKPIT AND CANOPY (after painting)

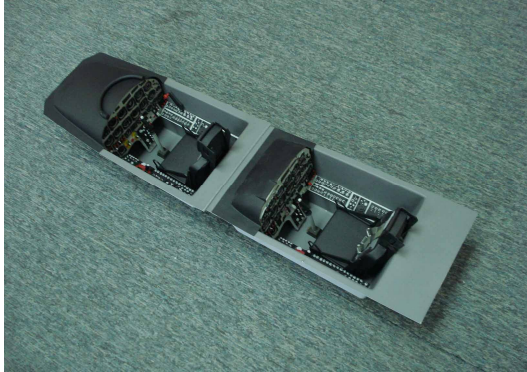

Photo 59



Photo 60

- Check free operation of actuator lifting the canopy. Open up hole if needed.
- Plumb air line and fit 2 x quick disconnects.
- Cut cockpit sides to clear fuselage and canopy frame.
- Glue ply strip to bottom of cockpit to reinforce area for screws holding cockpit.
- Slide cockpits into position.
- Secure the cockpit with 2mm screws.
- Refit canopy actuator and check operation.
- Fit glass.



Skymaster
ARF PLUS

T33 arf pro

Assembly & Operation Manual

EQUIPMENT INSTALLATION INTO T33

□ Equipment installation is a personal venture. There is one golden rule: Do it as neat and logical as possible! This will make fault finding and service of components easier. The F80 basically consist of 6 circuits!

1. Servo wires
2. Power cables
3. Data cables
4. Pneumatic pipes
5. Fuel pipes
6. RX cable / Satellite Receivers

Please try and separate these circuits as far as possible. It is advisable not to run RX cables near any kind of electrical fields. Make all switches and filler valves and charging sockets easy accessible

- The T33 will come out tail heavy if you do not plan installation. It is very important to install all equipment as far forward as possible.
- I have installed 2 x RX + 2 X ECU batteries in nose.
- I have installed a UAT before CG. This will always be full of fuel and will help with the final adjustment of CG.

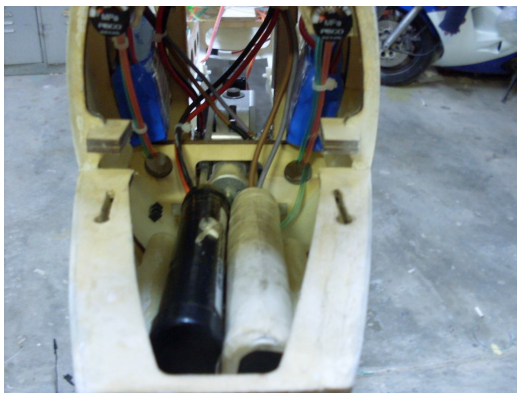

Photo 62

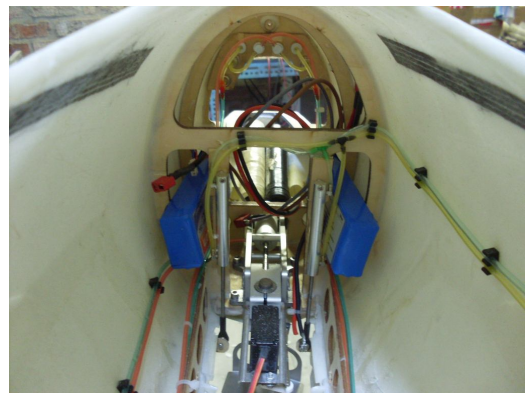

Photo 63

Skymaster
ARF PLUS

T33 arf pro

Assembly & Operation Manual

BEFORE YOU FLY

It is assumed that the builder of this kit has acquired the basic skills and knowledge necessary to make a safe and functional radio control installation into a model. Therefore, these notes are intended only to assist that experience.

When inserting the main spar into wing, make sure it only enters the amount required. If you can slide complete main spar into 1 half of wing, it means the stopper were removed. Please measure correct distance for main spar and secure spar so that it does not slide more to one side than other. It must be symmetrical to both sides.

Travel adjust measured at root. Use Expo to suite your style.

1. Elevator	30mm	2. Rudder	20mm
3. Aileron	20mm	4. Flaps take off	30 degrees
5. Flaps landing	60 degrees		

NOTE : Make sure flaps travel same. Flaps should be deployed in landing circuit only below 90mph.

- CG 190mm—200mm from leading edge at root. Empty tanks, UAT full and wheels down. The CG can be changed to best fit your flying style. A forward position is safe and nose heavy configuration. Lot of elevator needed for take off and turns. **WARNING: Do not move CG back unless you are experience and have some feel of model before!**
- Weight Dry weight will be between 34 and 40 lbs depending equipment.
- PSI 80—100 psi for pneumatic system
- Power Make use of battery management system. Double up on batteries and make sure all wired can carry current needed to operate.
- TX RX Do a complete range check before flight. Do this with turbine running. Follow manufacturers instructions.
- Speed Set the maximum speed to 160mph! The prototype were tested with Jetcat P-120 turbines. More powerful turbines require extra care and extra reinforcing.
- Timer A timer can save your model. Get into the habit of programming the timer.



T33 arf pro

Assembly & Operation Manual

Take-Off

Do some taxi tests before your flight! Make sure you are familiar with all settings and make sure the model track straight on the ground without rudder input.

Choose a fine day for the maiden flight. Do not force a maiden flight!
Select take off flap or flight mode 1 and open throttle. Gently pull back on stick 50m down the runway. Raise the flaps and gear at safe altitude and let the model sit on rails.

Slow Flight

Most of the first flight should be utilized to get familiar with the slow speed flight characteristics. Select the flaps to the takeoff position; there should be no pitch change. Extend the gear and select full landing flaps; adjust the power to maintain level flight and a speed of about 80—90mph.

Climb to a safe altitude and slow the model to the edge of a stall to know where that edge is.

Landing

Fly a complete circuit before landing. Approach from the downwind side and lower the LG. Fly a complete circuit getting use to the power required. On the next circuit lower the flaps. If you have a headwind be very careful not to get below the power curve on the downwind side. Do not use speed brakes for landing on maiden. When you are happy and more experienced the speed brakes will slow model down faster.

Align the model and use throttle to control the descent! The elevators will stay very active even at low speed. Flare the model just before touch down. Let the model roll out and apply brakes.

Taxi back and do necessary adjustments to customize T33 for your need!

We at Skymaster wish you many happy flights with your Shooting Star! Add some more scale options like drop tanks etc. Before and after landing slide open canopy for extra realism. Add landing lights and machine guns and your F80 will be just like real thing.

Anton Lin and Skymaster Team!



T33 arf pro

Assembly & Operation Manual

OPTIONAL SCALE PARTS

The T33 can be fitted with 3 different wing tanks. Only 1 set of tanks will be supplied with each kit. Customer to decide which set. Below is tip tanks and opening canopy.



Photo 64



Photo 65

Speed brakes already installed.



Photo 66



Photo 67

Landing lights.



Photo 68

Skymaster
ARF PLUS